



5 ϕ 5 \times 7 Single Color AllnGaP Dot Matrix LED Displays

LTP-2057A/2157A Series

Features

- 2.0 Inch (50.80mm) matrix height.
- Low power requirement.
- Single plane, wide viewing angle.
- Solid state reliability.
- 5 \times 7 array with X-Y select.
- Compatible with usascil and ebcdic codes.
- Stackable horizontally.
- Choices of two matrix orientation.
- Cathode row or cathode column.
- Easy mounting on P.C. board.
- Categorized for luminous intensity.
- Single color displays have the choices of three color- AllnGaP Super Red/AllnGaP red orange/AllnGaP amber yellow.

Package Dimensions

LTP-2057A/2157A

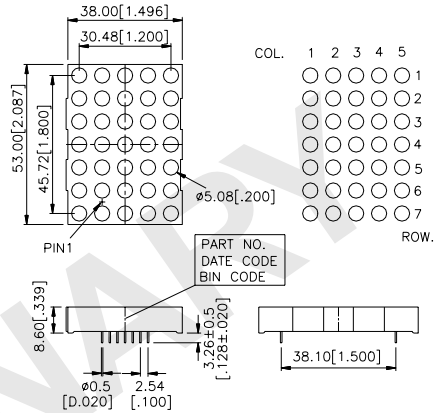

Description

The LTP-2057/2157A series are 2.0 inch (50.8mm) matrix height 5 \times 7 dot matrix displays. All device have gray face and white segment.

The AllnGaP super red, AllnGaP red orange and AllnGaP amber yellow series device utilize LED chips which are made from AllnGaP on a non-transparent GaAs substrate.

Notes: All dimensions are in millimeters (inches). Tolerance: \pm 0.25mm (0.01") unless otherwise noted.

Devices

Part No.			Description	Internal Circuit Diagram
AllnGaP Super Red	AllnGaP Red Orange	AllnGaP Amber Yellow		
LTP-2057AKR	LTP-2057AKA	LTP-2057AKY	Anode Column, Cathode Row	A
LTP-2157AKR	LTP-2157AKA	LTP-2157AKY	Cathode Column, Anode Row	B

Pin Connection

Pin No.	Connection	
	A.LTP-2057A	B.LTP-2157A
1.	Cathode Row 5	Anode Row 5
2.	Cathode Row 7	Anode Row 7
3.	Anode Column 2	Cathode Column 2
4.	Anode Column 3*1	Cathode Column 3*1
5.	Cathode Row 4*2	Anode Row 4*2
6.	Anode Column 5	Cathode Column 5
7.	Cathode Row 6	Anode Row 6
8.	Cathode Row 3	Anode Row 3
9.	Cathode Row 1	Anode Row 1
10.	Anode Column 4	Cathode Column 4
11.	Anode Column 3*1	Cathode Column 3*1
12.	Cathode Row 4*2	Anode Row 4*2
13.	Anode Column 1	Cathode Column 1
14.	Cathode Row 2	Anode Row 2

- Notes: 1.Pin 4 & 11 are internally connected.
2.Pin 5 & 12 are internally connected.

Internal Circuit Diagrams

A.LTP-2057A

B.LTP-2157A

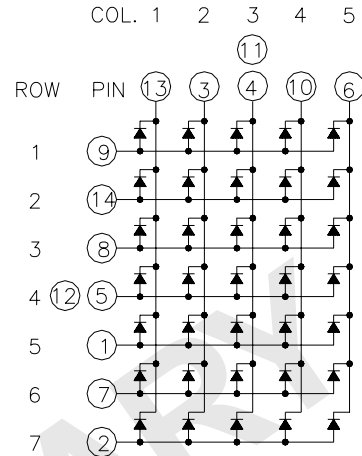
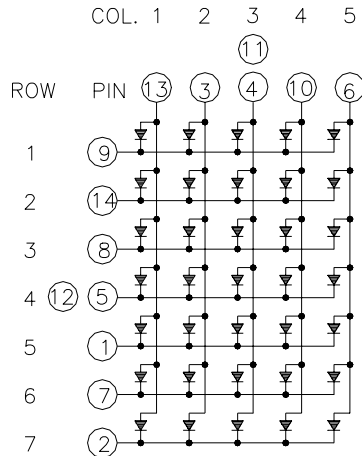

Absolute Maximum Ratings at Ta=25°C

Parameter	AllnGaP Super Red	AllnGaP Red Orange	AllnGaP Amber Yellow	Unit
Average Power Dissipation Per Dot	36	36	36	mW
Peak Forward Current Per Dot	100	100	100	mA
Average Forward Current Per Dot	13	13	13	mA
Derating Linear from 25°C Per Dot	0.17	0.17	0.17	mA/°C
Reverse Voltage Per Dot	5	5	5	V
Operating Temperature Range	-35°C to +85°C			
Storage Temperature Range	-35°C to +85°C			
Solder Temperature 1/16 Inch Below Seating Plane for 3 Seconds at 260°C				

LTP-2057AKR/2157AKR

Parameter	Symbol	Min.	Typ.	Max.	Unit	Test Condition
Average Luminous Intensity	I _v	2100	4600		μ cd	I _F =32mA 1/16 Duty
Peak Emission Wavelength	λ _P		639		nm	I _F =20mA
Spectral Line Half-Width	Δλ		20		nm	I _F =20mA
Dominant Wavelength	λ _d		631		nm	I _F =20mA
Forward Voltage, any Dot	V _F		2.0	2.6	V	I _F =20mA
Reverse Current, any Dot	I _R			100	μ A	V _R =5V
Luminous Intensity Matching Ratio	I _{v-m}			2:1		I _F =10mA

LTP-2057AKA/2157AKA

Parameter	Symbol	Min.	Typ.	Max.	Unit	Test Condition
Average Luminous Intensity	I _v	2100	4600		μ cd	I _F =32mA 1/16 Duty
Peak Emission Wavelength	λ _P		621		nm	I _F =20mA
Spectral Line Half-Width	Δλ		18		nm	I _F =20mA
Dominant Wavelength	λ _d		615		nm	I _F =20mA
Forward Voltage, any Dot	V _F		2.05	2.6	V	I _F =20mA
Reverse Current, any Dot	I _R			100	μ A	V _R =5V
Luminous Intensity Matching Ratio	I _{v-m}			2:1		I _F =10mA

Parameter	Symbol	Min.	Typ.	Max.	Unit	Test Condition
Average Luminous Intensity	I _v	2100	4600		μ cd	I _p =32mA 1/16 Duty
Peak Emission Wavelength	λ _P		595		nm	I _F =20mA
Spectral Line Half-Width	Δλ		15		nm	I _F =20mA
Dominant Wavelength	λ _d		592		nm	I _F =20mA
Forward Voltage, any Dot	V _F		2.05	2.6	V	I _F =20mA
Reverse Current, any Dot	I _R			100	μ A	V _R =5V
Luminous Intensity Matching Ratio	I _v -m			2:1		I _F =10mA

Note: Luminous intensity is measured with a light sensor and filter combination that approximates the CIE (Commission Internationale De L'Eclairage) eye-response curve.

Typical Electrical/Optical Characteristic Curves (25°C Ambient Temperature Unless Otherwise Noted)

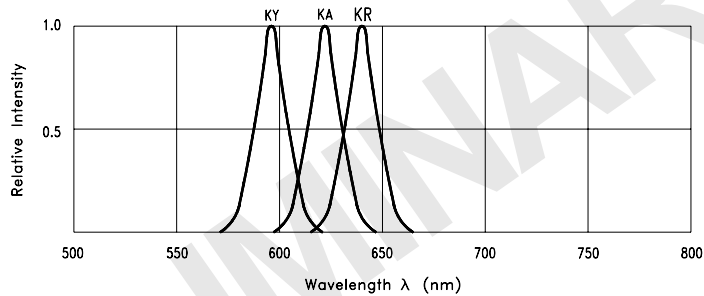

Fig.1 Relative Intensity vs. Wavelength

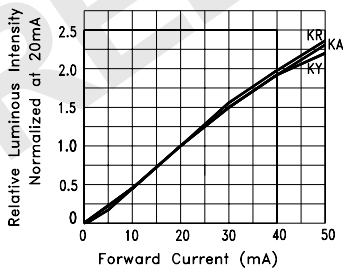

Fig 2. Relative Luminous Intensity vs. Forward Current

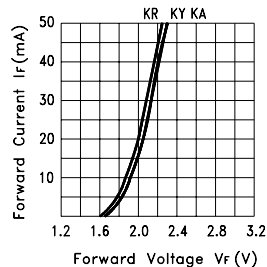

Fig.3 Forward Current vs. Forward Voltage

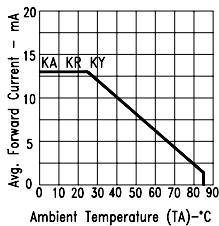

Fig 4. Max. Average Forward Current vs. Ambient Temperature.

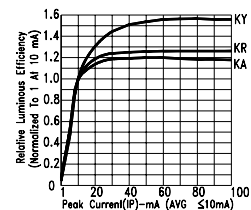

Fig5. RELATIVE LUMINOUS EFFICIENCY (LUMINOUS INTENSITY PER UNIT CURRENT) VS. PEAK CURRENT